

Shop Drawings



Typical Custom Shower

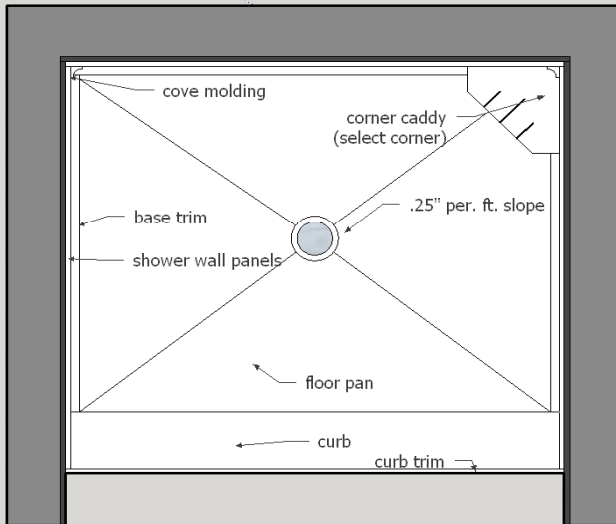

Typical Custom Shower

Top View



-  The Marble Factory engineered marble, onyx, granite or solicoat
-  Water resistant Drywall
-  Framing / walls



Notes

August 2014

Typical Custom Shower

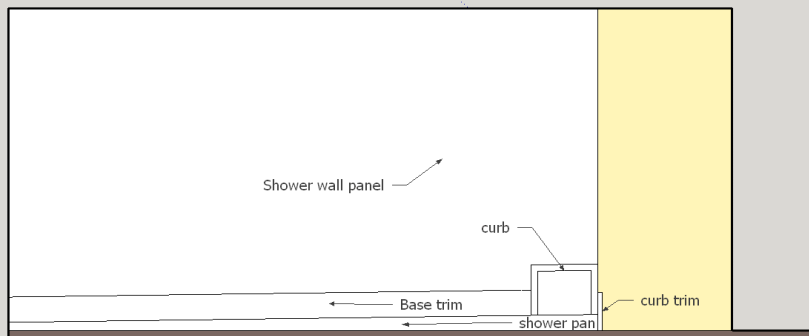
Side View





-  The Marble Factory engineered marble, onyx, granite, travertine or solicoat.
-  Finished Wall
-  Substrate

Typical Shower Drain Profile

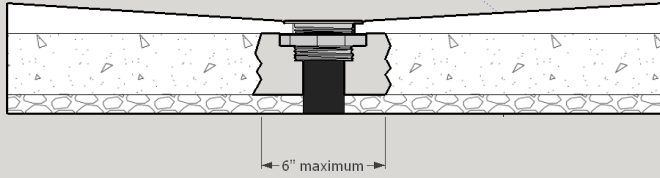
Side View



-  The Marble Factory engineered shower base
-  Concrete / Gravel substrate
-  Shower strainer / ABS pipe



Notes

August 2014

Typical Shower Drain Profile

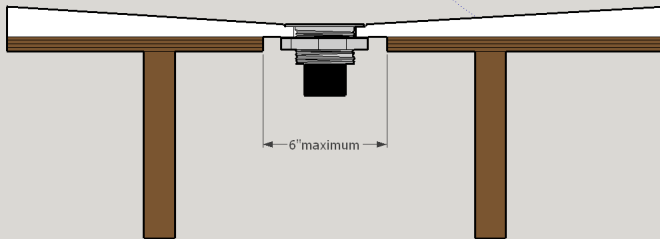
Side View



-  The Marble Factory engineered shower base
-  Wood Substrate
-  Shower strainer / ABS pipe

Notes

August 2014

Typical Strainer Configuration

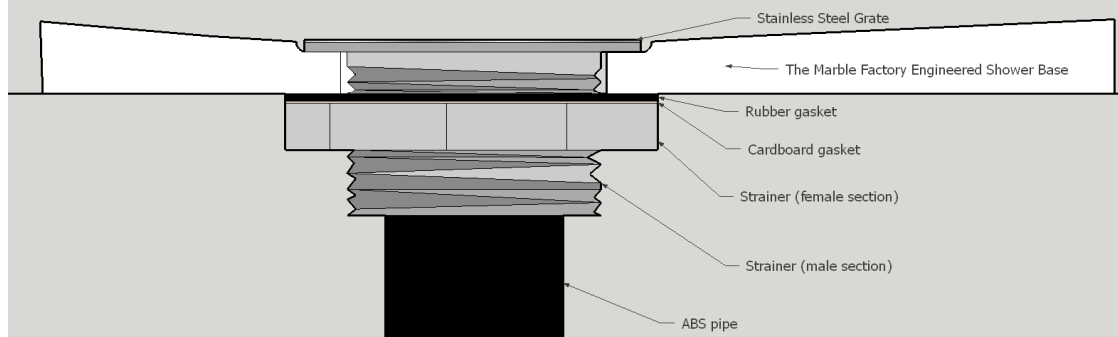

Custom Shower base is measured once the walls have been framed. Locate drain location.

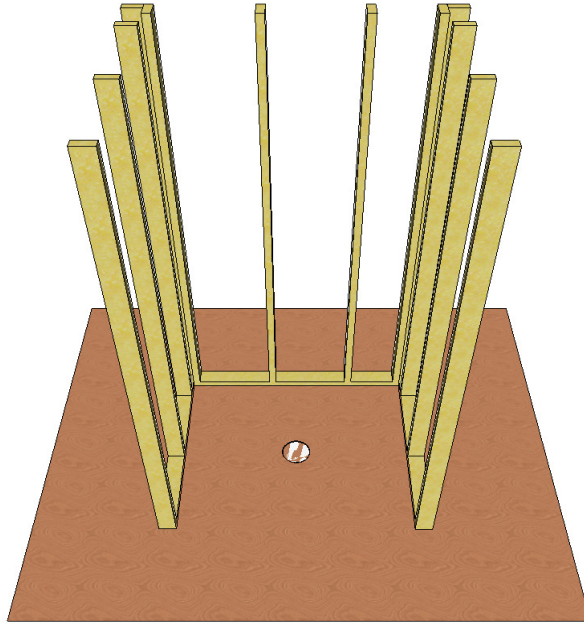

Custom Shower base is set on the floor and the plumbing is connected to the strainer provided. Shower valve is installed. Any blocking for grab bars or accessories should be installed.

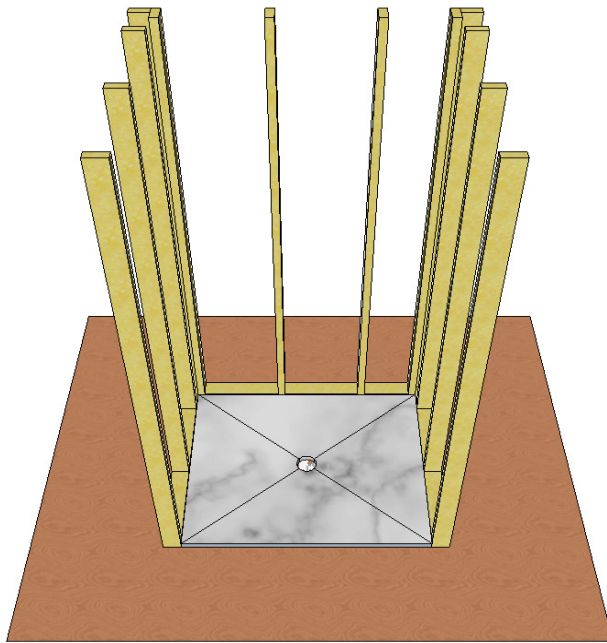

Once the Custom Shower base has been installed and adequate drainage confirmed. Water resistant drywall is applied to the framing.

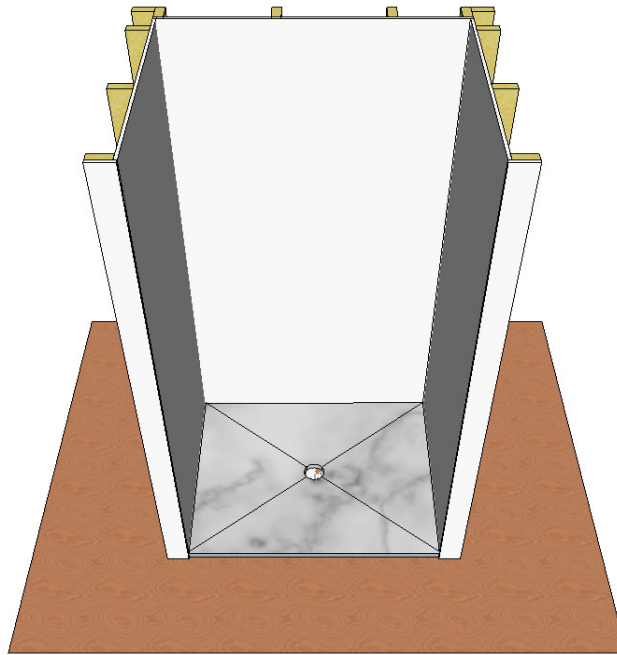

Engineered panels are cut, drilled and silconed to the Drywall.

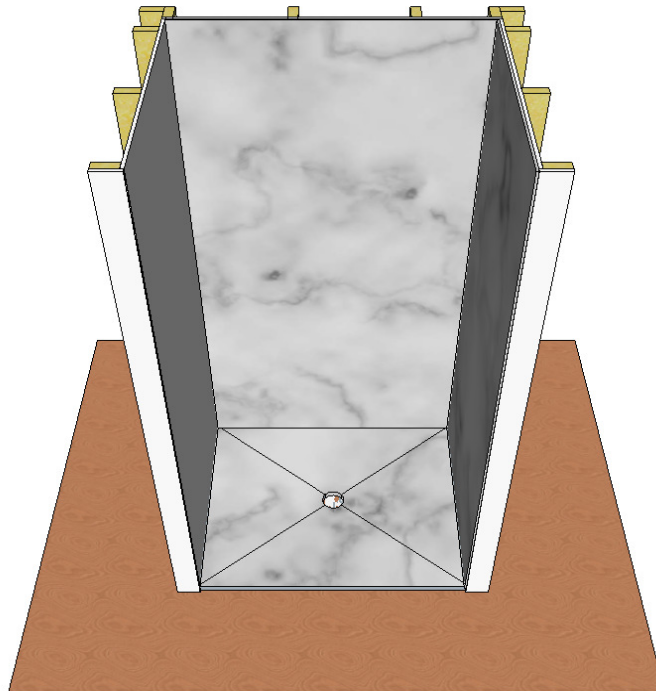

After the shower panels are installed, the curb and trim are installed around the bottom perimeter.

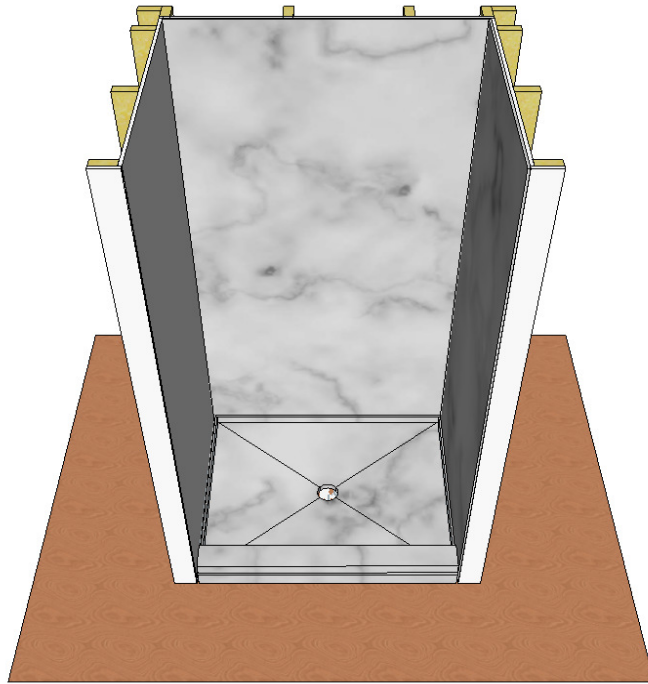

The final step is to install the corner caddy and inside cove moldings. The seams are now ready to finish silicone to provide the final seal. Please allow 24 hours for the silicone to cure.

The shower door or showercurtain is now ready to install. Install valve trim and accessories. Install grab bars (if required)

